

THE LOOP EXPERIENCE

Seductive attraction



**NOBILIS**





Backstage

## BEHIND THE SCENES

Atmosphere and style

A contemporary living setting unites in a single functional context all the elements required to meet the needs of modern life. The borders between rooms become fluid in a loft, the architectural solution preferred by the most demanding customers. Cool atmosphere and impeccable style: mezzanine, bedroom and, most importantly, a carefully designed and technological bathroom, the star of daily domesticity in the home. Attention to detail, linearity, clear and minimalist shapes: the profile of the mixer and the spectacular intersection of body and spout, with refined blurring and extreme lighting, define and reflect the character of the entire structure.

Uno spazio abitativo contemporaneo riunisce in un unico contesto funzionale tutti gli elementi essenziali per rispondere alle necessità della vita moderna. I confini tra le stanze si fanno fluidi all'interno di un loft, la soluzione architettonica prediletta dalla clientela più esigente. Atmosfera cool e stile impeccabile: soppalco, camera da letto e, soprattutto, un ambiente bagno curato e tecnologico, vero protagonista della quotidianità domestica. Attenzione al dettaglio, linearità, forme pulite e minimali: il profilo del miscelatore e la spettacolare intersezione tra corpo e bocca, tra sfocature ricercate e luci estreme, definisce il carattere dell'intera struttura.

Un lieu d'habitation contemporain réunit dans un unique contexte fonctionnel tous les éléments essentiels pour les besoins de la vie moderne. Les limites entre les pièces deviennent fluides à l'intérieur d'un loft, la solution préférée de la clientèle la plus exigeante. Atmosphère cool et style impeccable : mezzanine, chambre à coucher et un espace de bains soigné et technologique, la véritable vedette du quotidien domestique. Attention envers le moindre détail, linéarité, formes épurées : le profil du mitigeur et la spectaculaire intersection entre le corps et le bec, entre flous recherchés et lumières extrêmes, définit le caractère de toute la structure.

Un espacio residencial contemporáneo reúne en un único contexto funcional todos los elementos esenciales para las necesidades de la vida moderna. Los límites entre habitación y habitación se vuelven más fluidos dentro de un loft, la solución preferida de los clientes más exigentes. Ambiente fresco y estilo impecable: altillo, dormitorio y, sobre todo, un ambiente de baño cuidado y tecnológico, el verdadero protagonista de la cotidianidad doméstica. Atención al detalle, linealidad y formas limpias: el perfil del mezclador y la espectacular intersección entre cuerpo y caño, entre refinados desenfoques y luces extremas, define el carácter de toda la estructura.



External backstage



Internal backstage







## PROJECT INSPIRATIONS

Conversation with Piet

When the best technology is applied to aesthetics, extraordinary realities spring forth - the absolute design of Loop pays homage to the technological efficiency it descends from. Piet Billekens designs an extremely complete collection for Nobili: there are over fifteen models of wash basin and, in addition to the standard version with aerator jet, all the mixers are available with a spectacular cascade spout, which provides a natural and organic flow. The considerable visual impact, combined with the feelings born from the flow of water, provide pleasure like no other in the bathroom. A refined range of accessories defines the project in every detail.

Quando la migliore tecnologia si dona all'estetica, scaturiscono realtà straordinarie: l'assoluto design di Loop è omaggio all'efficienza tecnologica da cui discende. Piet Billekens disegna per Nobili una collezione estremamente completa: i lavabi annoverano oltre quindici versioni e, oltre al modello standard con getto aeratore, è disponibile anche la scenografica bocca a cascata, capace di erogare un flusso naturale e organico. Il notevole impatto visivo unito alle intense sensazioni offerte dallo scorrere dell'acqua regalano un piacere senza paragoni all'interno della sala da bagno. Una ricercata gamma di accessori definisce il progetto nel suo dettaglio.



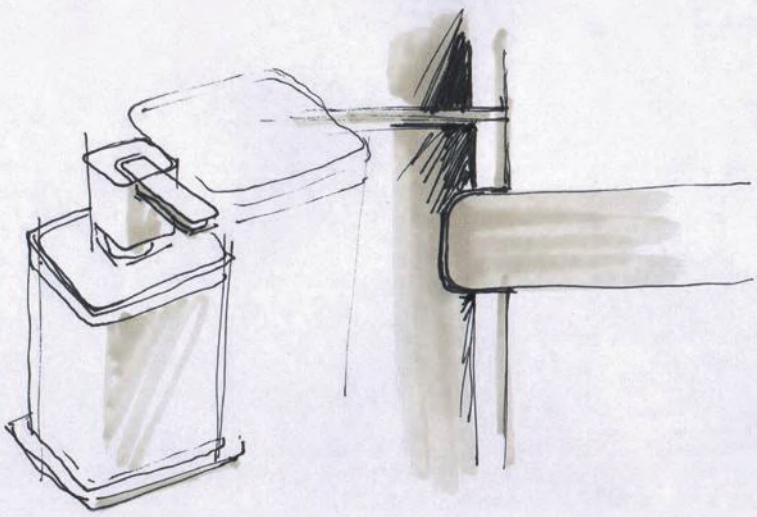
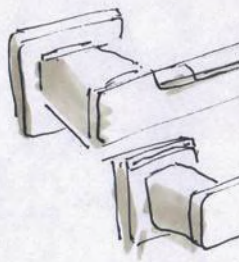
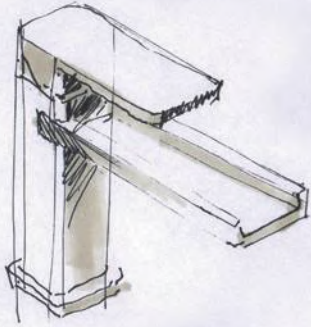
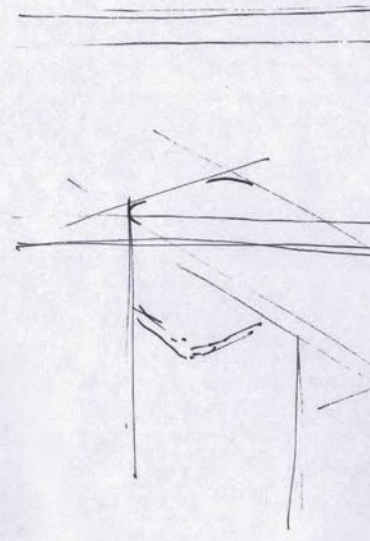
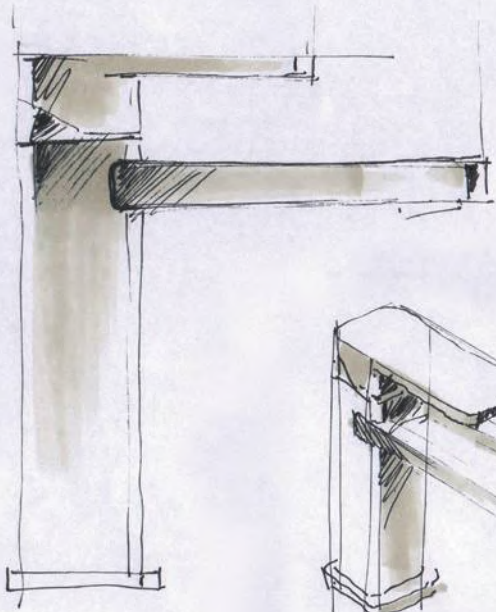
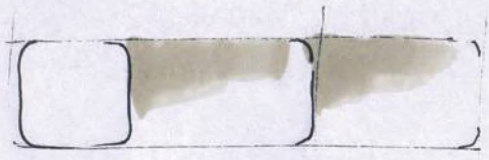

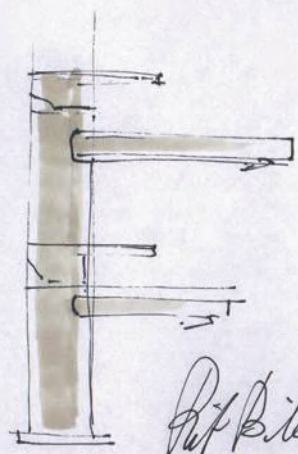
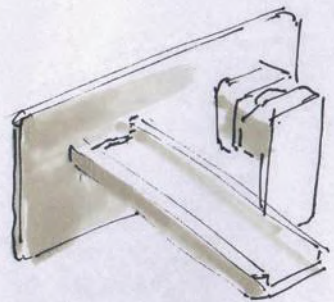
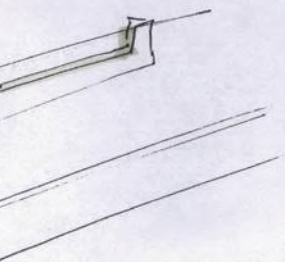
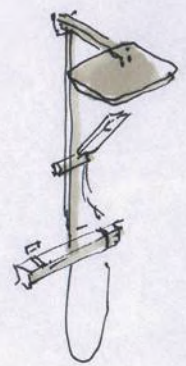
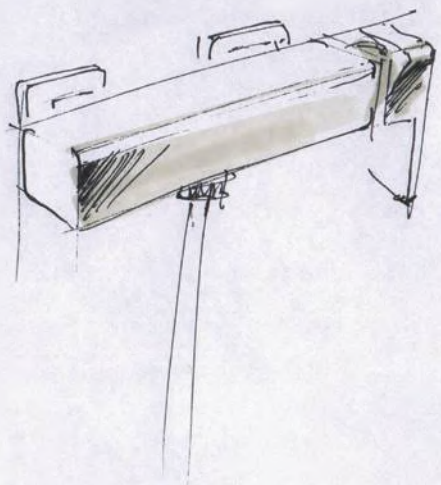
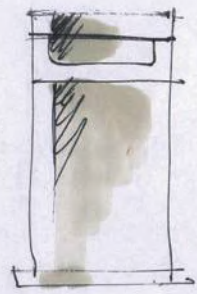
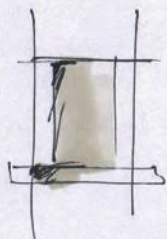

Art Bill



Single control washbasin





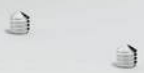



Single control washbasin with cascade spout

Single control washbasin with cascade spout





Quand la meilleure technologie se marie à l'esthétique, des réalités extraordinaires jaillissent : le design de Loop est un hommage à l'efficacité technologique dont il descend. Piet Billekens conçoit une collection extrêmement complète pour Nobili : les lavabos présentent plus de quinze versions et, en plus du modèle à jet aérateur, est également disponible le bec à cascade, capable de distribuer un flux naturel et organique. Le remarquable impact visuel allié aux intenses sensations apportées par l'écoulement de l'eau offre un plaisir sans égal à l'intérieur de la salle de bains. Une gamme recherchée d'accessoires définit le projet dans les détails.

Cuando la mejor tecnología se pone al servicio de la estética, surgen realidades extraordinarias: el diseño de Loop es un tributo a la eficiencia tecnológica de la que nace. Piet Billekens diseña una colección extremadamente completa para Nobili: los lavabos se presentan en más de quince versiones y, además del modelo con chorro aireador, también está disponible el caño de cascada, capaz de proporcionar un caudal natural y orgánico. El notable impacto visual, combinado con las intensas sensaciones que ofrece el fluir del agua, regalan un placer sin igual en el ambiente baño. Una refinada gama de accesorios define el proyecto en todos sus detalles.







## WELLNESS AND HARMONY

Order and elegance

Intensely fragranced candles combined with the element of water - the supreme pleasure of a relaxing bath brings out emotions each of us has always held hidden inside. The deck-mounted 4-hole set is the frame for regenerating moments of peace, while the large aerator means the bath can be filled very quickly. Alternatively, the wall-mounted versions conceal the most advanced technology inside them - the quality of a product that can express the best combination of function and design. Business and pleasure are also harmoniously united in the two-way single control flush-fit system, that transforms the bathtub setting into an intensely pleasant moment every day.

Candele dagli aromi intensi, l'unione con l'elemento acqua: il benessere infinito di un bagno rilassante evoca sensazioni da sempre custodite in ognuno di noi. La batteria quattro fori bordo vasca incornicia rigeneranti momenti di tranquillità, mentre l'aeratore di grandi dimensioni permette di riempire la vasca con tempestività. In alternativa, le versioni a parete celano al loro interno la più sofisticata tecnologia, prerogativa di un prodotto in grado di esprimere la migliore sintesi tra funzionalità e design. L'utile e il dilettevole si sposano armoniosamente anche nell'incasso monocomando a due vie, che trasforma l'ambiente vasca in un intenso piacere quotidiano.

Bougies aux arômes intenses, l'union avec l'élément eau : le bien-être infini d'un bain relaxant évoque des sensations retenues en chacun de nous. Le mélangeur quatre trous bord baignoire encadre des moments régénérants de tranquillité, tandis que l'aérateur aux grandes dimensions permet de remplir rapidement la baignoire. Les versions murales cachent à l'intérieur la technologie la plus sophistiquée, une prérogative d'un produit capable d'exprimer la meilleure synthèse entre fonctionnalité et design. L'utile et l'agréable se marient harmonieusement dans le système encastré mitigeur monocommande à deux voies, qui transforme l'espace baignoire en un intense plaisir quotidien.

Velas con aromas intensos, la unión con el elemento agua: el inmenso bienestar de un baño relajante evoca sensaciones sumamente apreciadas para cada uno de nosotros. La batería de 4 agujeros del borde bañera enmarca momentos de regeneradora paz y tranquilidad, mientras que el gran tamaño del aireador permite llenar la bañera rápidamente. Las versiones de pared ocultan la tecnología más sofisticada en su interior, prerrogativa de un producto capaz de expresar la mejor síntesis entre funcionalidad y diseño. Practicidad y placer se funden armoniosamente en el sistema monomando empotrado de dos vías, transformando el ambiente bañera en un intenso placer diario.



Deck-mounted 4 hole set





## SHOWER SYSTEM

Absolute pleasure

The shower area transforms water into a wellness ritual with its balanced and minimalist design: the body jets have a massaging and toning action, to begin the day with the right energy or even to eliminate stress at the end of the day. Multiple wellness solutions are possible by freely combining the shower elements, creating refined and contemporary settings: the charm and modern style of rounded edges are expressed in the essential nature of the flush-fit 2-way single control mixer. The purity of Loop collection is also evident in its many dedicated accessories, which can expand the collection's features to complete the bathroom with the best style coherence.

L'ambiente doccia trasforma l'acqua in rituale benessere attraverso un design equilibrato ed essenziale: i getti corpo massaggiano e tonificano, per iniziare la giornata con la giusta energia o concluderla eliminando lo stress. Combinando a piacere i componenti doccia è possibile dare vita a molteplici soluzioni wellness, dedicate a spazi attuali e ricercati: il fascino e la modernità dello spigolo arrotondato si esprimono attraverso l'essenzialità del miscelatore monocomando incasso a due vie. La purezza di Loop è evidente anche nei numerosi accessori dedicati, capaci di estendere i tratti della collezione per completare la sala da bagno con la migliore coerenza stilistica.



L'espace douche transforme l'eau en bien-être rituel à travers un design équilibré et essentiel : les jets massent et tonifient le corps, pour commencer la journée avec la bonne énergie ou pour la terminer en éliminant le stress. En combinant à sa guise les composants de douche, il est possible de donner vie à de multiples solutions de bien-être, dédiées à des espaces actuels et recherchés : le charme de l'arête arrondie s'expriment à travers l'épure du mitigeur monocommande encastré à deux voies. La pureté de Loop est évidente même dans les nombreux accessoires, capables d'étendre les traits de la collection pour compléter la salle de bains avec la meilleure cohérence stylistique.

El ambiente ducha convierte el agua en un ritual de bienestar a través de un diseño equilibrado y esencial: los chorros masajean y tonifican, para empezar el día con la energía adecuada o para terminarlo deshaciéndote del estrés. Al combinar los componentes de la ducha a voluntad, es posible crear múltiples soluciones dedicadas a espacios actuales y refinados: el encanto y la modernidad del borde redondeado se expresan a través de la esencialidad del mezclador monomando empotrado de dos vías. La pureza de Loop también se hace evidente en sus numerosos accesorios, capaces de realzar las características de la colección para completar el baño con la mejor coherencia estilística.







2-way flush-fit single control shower mixer, flush-fit bodyjet



Hanger, towel holder

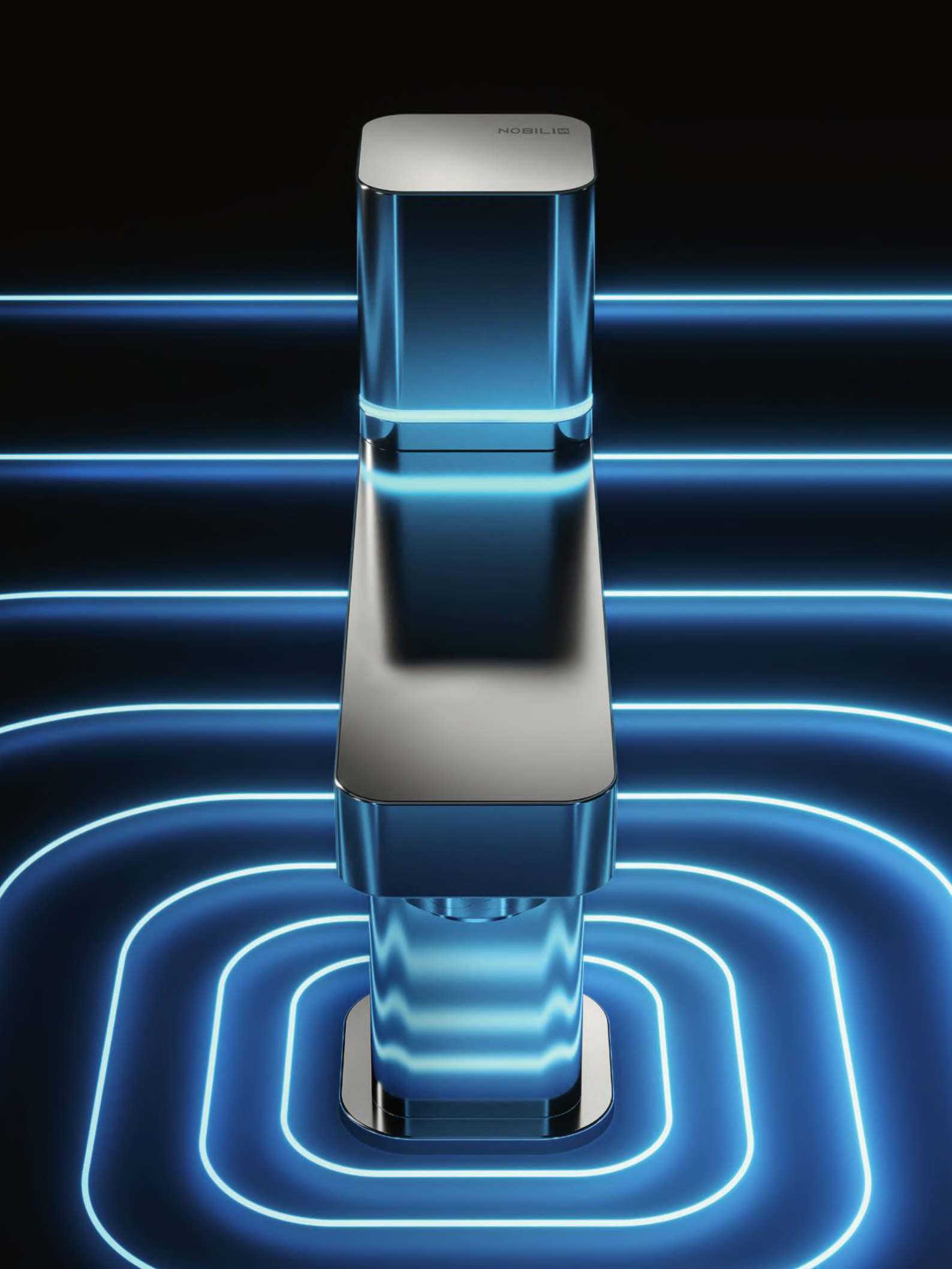

# TRAILS OF LIGHT

Hi-tech heart

Efficacy combines science and magic: the temperature, the flow and the adjustments to the flow of water are controlled by an electronic unit.

L'efficacia combina scienza e magia: l'erogazione del flusso, la regolazione di portata e temperatura sono controllate da un'unità elettronica.

L'efficacité associe science et magie : la distribution du flux, le réglage du débit et la température sont contrôlés par une unité électronique.

La eficacia combina ciencia y magia: la erogación del flujo y la regulación del caudal y la temperatura están controladas por una unidad electrónica.

Electronic control





Electronic control washbasin with cascade spout

Electronic control washbasin



















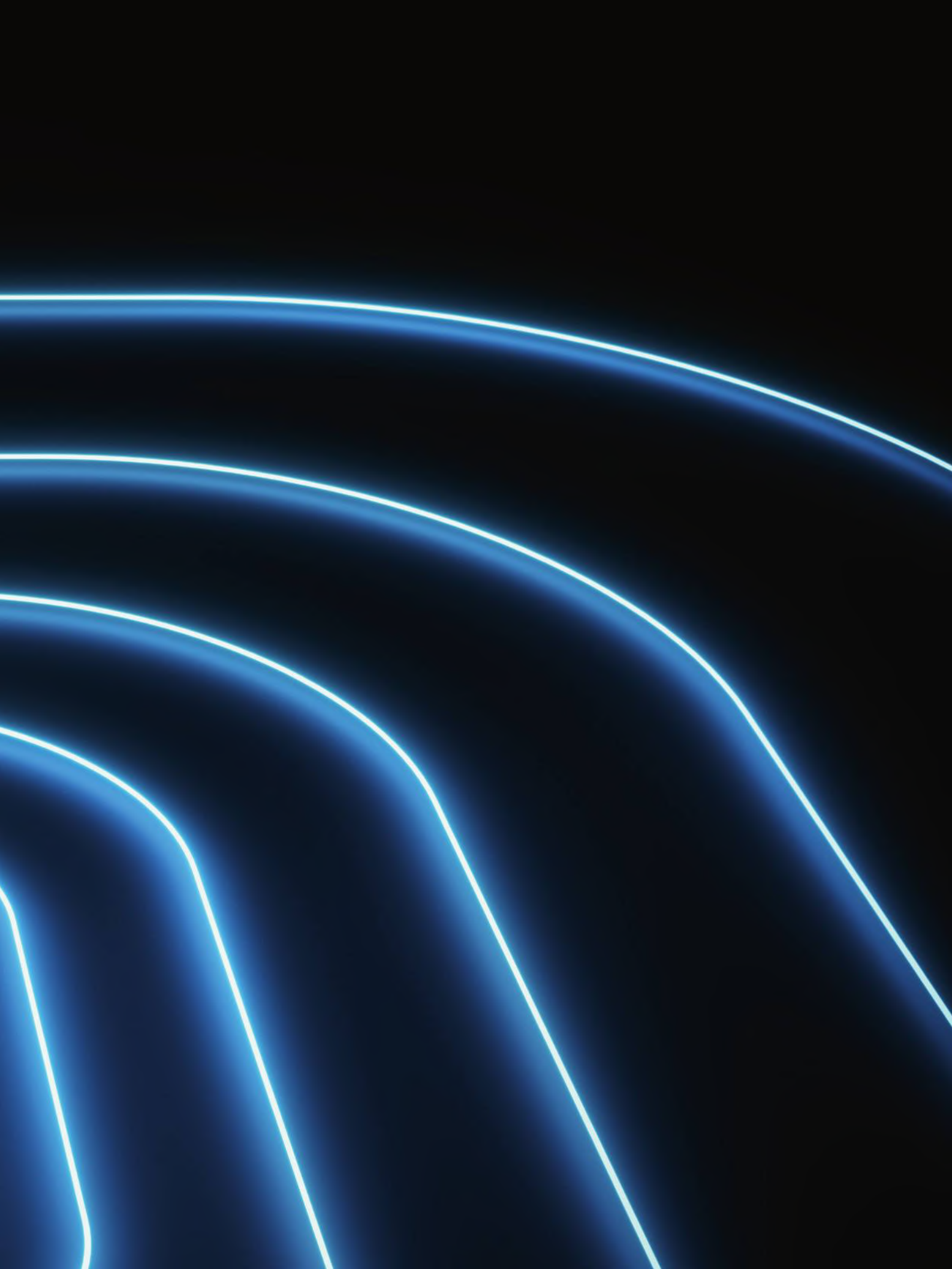

## MADE IN NOBILI

Italian pride

Nobili's mission was born and has deep roots in Italy, with considerable resources invested in improving the production process and adopting the most advanced technologies. The company perceives success as an incentive to improve further, renewing its efforts daily to offer absolute excellence. In 2013, before anyone else in the sector, introduced the "Made in Italy" marking on mixers. Thousands of customers worldwide are the most authoritative confirmation of the effectiveness of the choices made, while also confirming that the road to success is not paved with short-cuts but with constant commitment: something that underscores Nobili's work, day after day.

La mission di Nobili nasce e si radica in Italia, attraverso ingenti risorse destinate al perfezionamento del processo produttivo e all'adozione delle tecnologie più evolute. L'azienda vive il successo come stimolo a migliorarsi ulteriormente, rinnovando ogni giorno gli sforzi per offrire l'assoluta eccellenza. Nel 2013, prima tra tutti nel comparto, ha introdotto la marcatura "Made in Italy" sui miscelatori. Migliaia di clienti nel mondo costituiscono la più autorevole conferma della bontà delle scelte effettuate, ma testimoniano anche che la strada del successo non prevede scorciatoie, ma l'impegno costante che in Nobili è, da sempre, alla base del lavoro quotidiano.

La mission de Nobili est née et est ancrée en Italie, à travers d'importantes ressources destinées au perfectionnement du processus de production. L'entreprise vit son succès comme une incitation à s'améliorer ultérieurement, en renouvelant ses efforts pour offrir l'excellence totale. En 2013, elle a été la première de son secteur à introduire le marquage " Made in Italy " sur les mixeurs. Les milliers de clients représentent la confirmation la plus sûre de la qualité des choix effectués, mais montrent également que le chemin du succès ne prévoit pas de raccourci, mais un engagement constant, qui est depuis toujours à la base du travail quotidien chez Nobili.

La misión de Nobili nace y hunde sus raíces en Italia, manifestándose en enormes recursos destinados a perfeccionar el proceso de producción. La compañía experimenta el éxito como un incentivo para seguir mejorando, renovando sus esfuerzos para ofrecer la excelencia absoluta. En 2013 fue la primera empresa del sector en introducir la marca "Made in Italy" en sus mezcladores. Sus miles de clientes en todo el mundo confirman el acierto de las decisiones tomadas, pero también demuestran que el camino hacia el éxito no admite atajos, sino que requiere el compromiso constante que siempre ha constituido la base del trabajo cotidiano de Nobili.

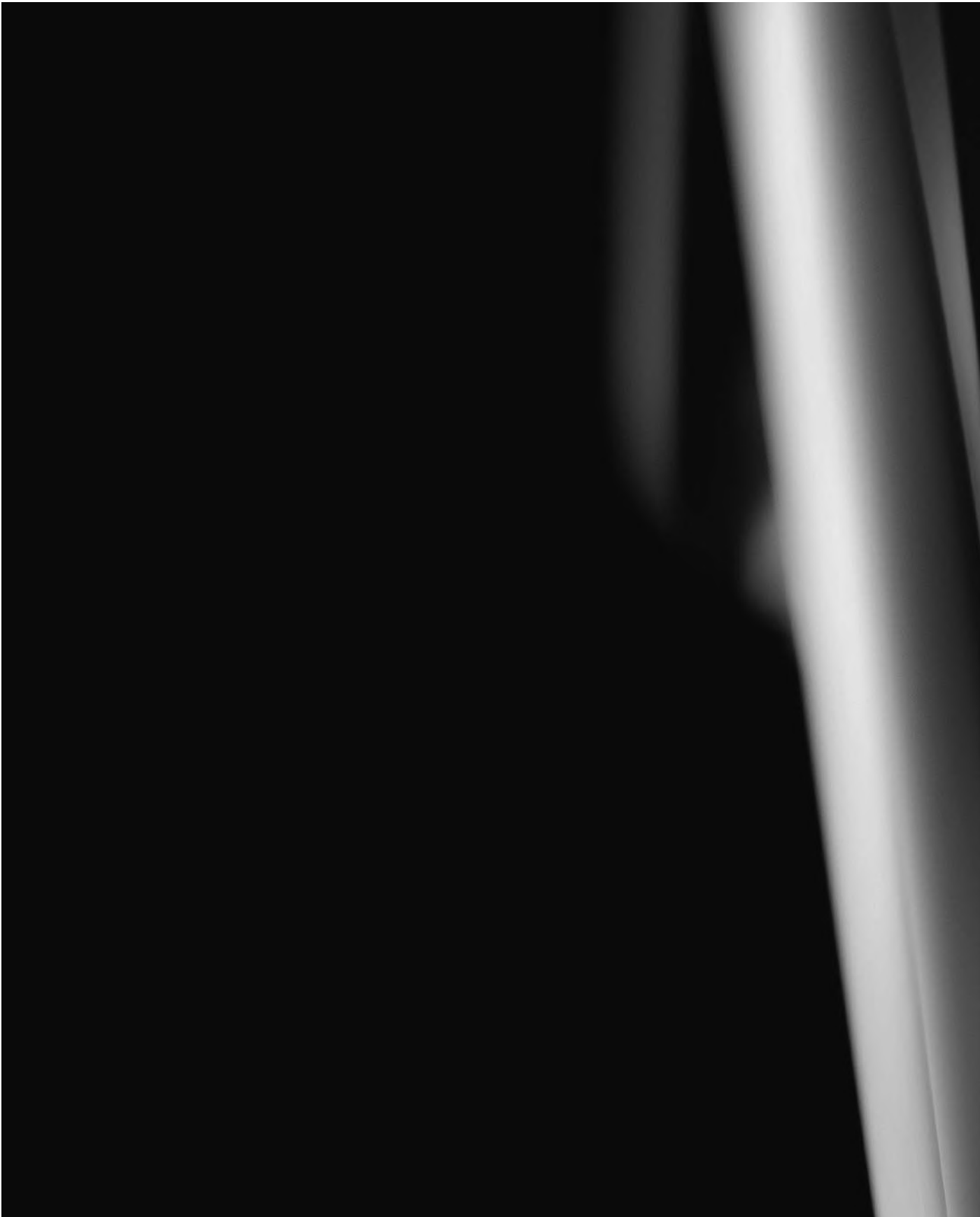



Made in Italy

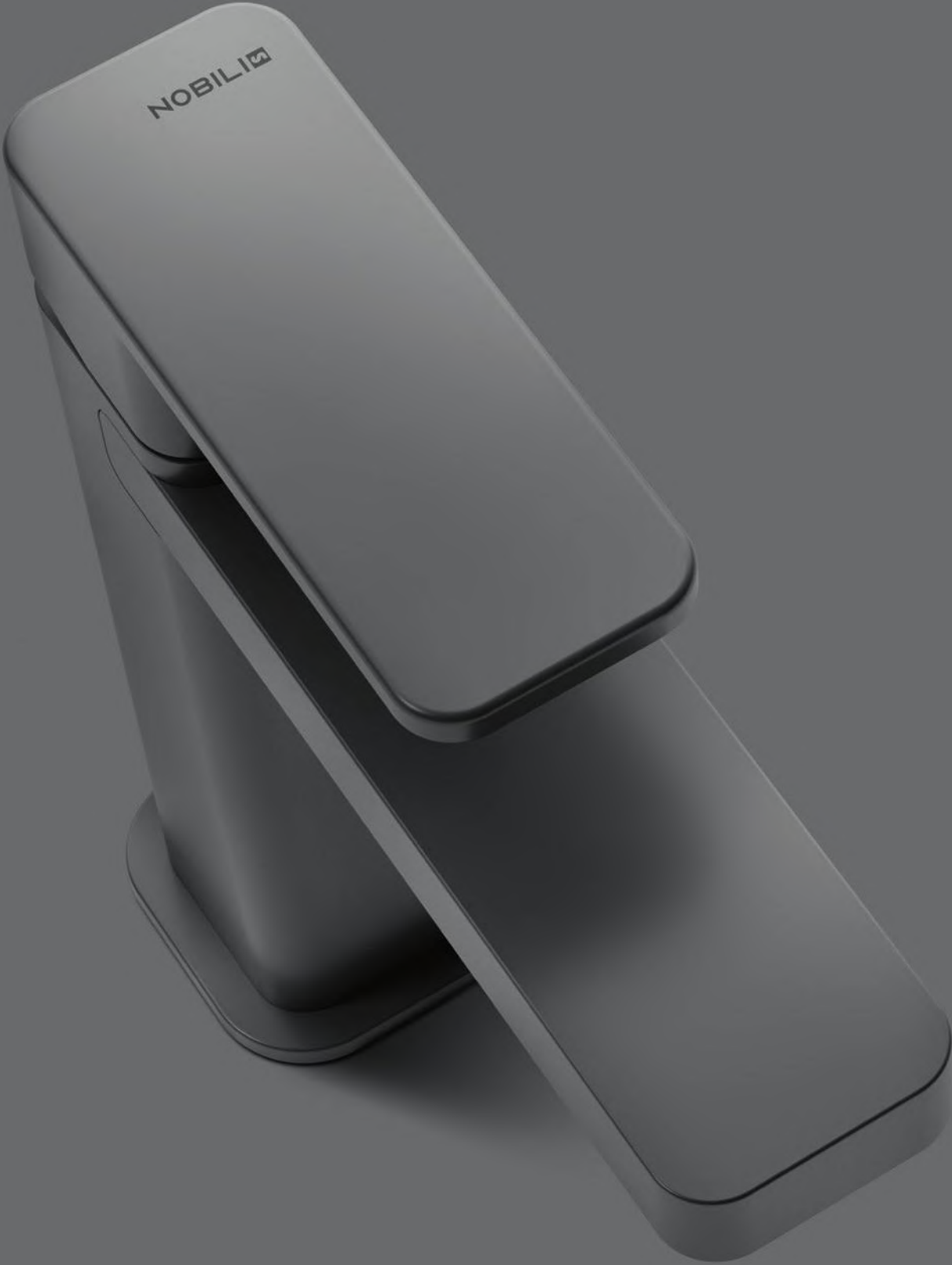





CARLO NOBILI RUBINETTERIE

via novara 29

28019 suno (no) italia

nobili.it

CREATIVE DIRECTION

marco venezano

elenia pallaro

IMAGES

varianti

widestudio



**NOBILIS**

ACATALOG / JANUARY 2021 / WE INVEST RESOURCES IN THE CONTINUOUS IMPROVEMENT OF THE PRODUCT AND OF PROCESSING METHODS. THE CATALOGUE MAY CONTAIN ARTICLES SUBJECT TO MODIFICATIONS. DUE TO THE PRINTING TECHNIQUE, THE COLOURS SHOWN ABOVE MAY VARY FROM THE TRUE COLOUR OF THE FINISH. BEFORE SUBMITTING AN ORDER, CONSULT OUR SALES NETWORK.

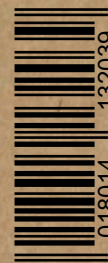

8 018014 132039